

Victoriaanse voorlijst

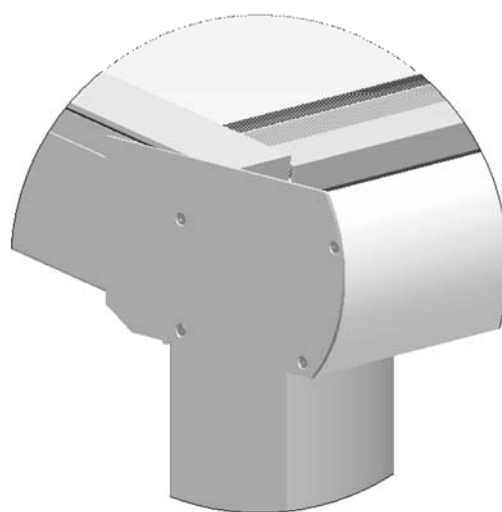

Ronde voorlijst

Piazza® Terrasoverkapping

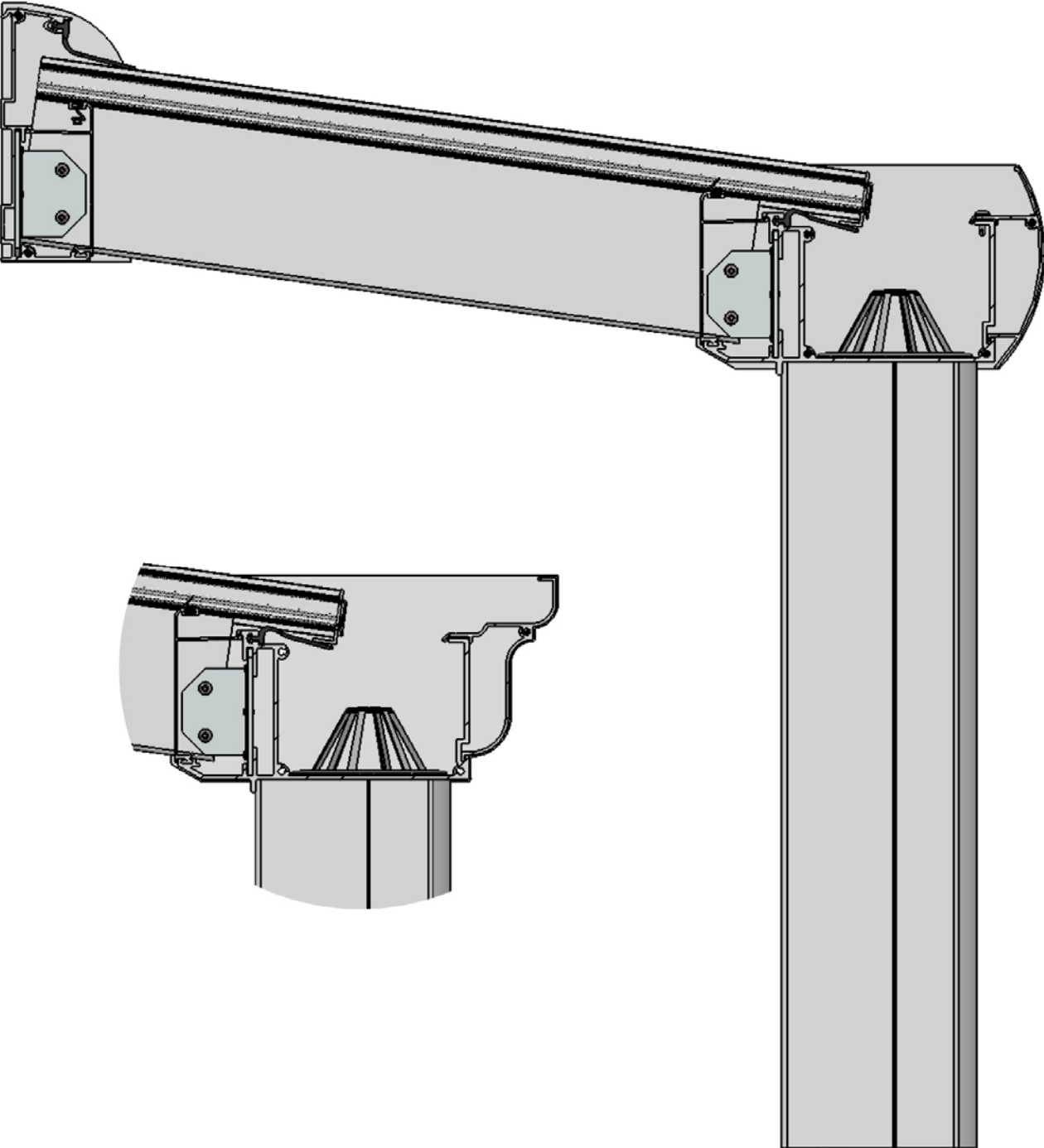

Piazza® Terrasoverkapping

Technische informatie over de Piazza kunt u middels uw inlogcode downloaden van onze site: www.avz.nl onder de link 'Inloggen dealers' (zie blz. 5 voor meer informatie).











Artikelnr.	Omschrijving	Lengte in m ¹ / Verp.eenheid	Uitvoering
7500 409-000	Alu goot terrasoverkapping	4,15	onbewerkt
7500 411-000	Idem	5,15	onbewerkt
7500 413-000	Idem	6,15	onbewerkt
7500 415-000	Idem	7,15	onbewerkt
7500 409-006	Alu goot terrasoverkapping	4,15	RAL 9010 wit
7500 411-006	Idem	5,15	RAL 9010 wit
7500 413-006	Idem	6,15	RAL 9010 wit
7500 415-006	Idem	7,15	RAL 9010 wit
7500 409-901	Alu goot terrasoverkapping	4,15	RAL 9001 crème
7500 411-901	Idem	5,15	RAL 9001 crème
7500 413-901	Idem	6,15	RAL 9001 crème
7500 415-901	Idem	7,15	RAL 9001 crème
7500 409-755	Alu goot terrasoverkapping (*=structuurlak)	4,15	RAL 7016 antraciet*
7500 411-755	Idem	5,15	RAL 7016 antraciet*
7500 413-755	Idem	6,15	RAL 7016 antraciet*
7500 415-755	Idem	7,15	RAL 7016 antraciet*

Maximale overspanning tussen staanders:
 bij toepassing Polycarbonaat 4 m.
 bij toepassing gelaagd glas 4.4.2 3 m. De goot dient in dit geval verstevigt te worden met onderstaande strip.











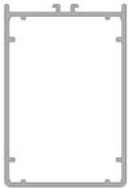





7500 522-000	Platstrip staal 79 x 8 mm	6,00	verzinkt
7700 360-000	Koppelstuk goot		onbewerkt
7500 489-000	Sierlijst goot rond	4,15	onbewerkt
7500 491-000	Idem	5,15	onbewerkt
7500 493-000	Idem	6,15	onbewerkt
7500 495-000	Idem	7,15	onbewerkt
7500 489-006	Sierlijst goot rond	4,15	RAL 9010 wit
7500 491-006	Idem	5,15	RAL 9010 wit
7500 493-006	Idem	6,15	RAL 9010 wit
7500 495-006	Idem	7,15	RAL 9010 wit
7500 489-901	Sierlijst goot rond	4,15	RAL 9001 crème
7500 491-901	Idem	5,15	RAL 9001 crème
7500 493-901	Idem	6,15	RAL 9001 crème
7500 495-901	Idem	7,15	RAL 9001 crème
7500 489-755	Sierlijst goot rond (*=structuurlak)	4,15	RAL 7016 antraciet*
7500 491-755	Idem	5,15	RAL 7016 antraciet*
7500 493-755	Idem	6,15	RAL 7016 antraciet*
7500 495-755	Idem	7,15	RAL 7016 antraciet*





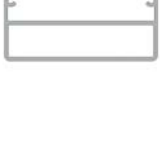

Piazza® Terrasoverkapping

	Artikelnr.	Omschrijving	Lengte in m ¹ / Verp.eenheid	Uitvoering
	7500 503-000	Sierlijst goot Victoriaans	6,15	onbewerkt
	7500 505-000	Idem	7,15	onbewerkt
	7500 503-901	Sierlijst goot Victoriaans	6,15	RAL 9001 crème
	7500 505-901	Idem	7,15	RAL 9001 crème
	7500 503-755	Sierlijst goot Victoriaans (*=structuurlak)	6,15	RAL 7016 antraciet*
	7500 505-755	Idem	7,15	RAL 7016 antraciet*
	Sierlijst goot Victoriaans in RAL 9010 wit is op bestelling leverbaar.			
	7700 322-090	Eindkap rond onbewerkt	Eindkap rond	
	7700 322-006	Idem		RAL 9010 wit
	7700 322-901	Idem		RAL 9001 crème
	7700 322-755	Idem (*=structuurlak)		RAL 7016 antraciet*
	7700 323-090	Eindkap Victoriaans		onbewerkt
	7700 323-901	Idem		RAL 9001 crème
	7700 323-755	Idem (*=structuurlak)		RAL 7016 antraciet*
	Eindkap Victoriaans in RAL 9010 wit is op bestelling leverbaar.			
	7700 320-090	Afdekplaat muurprofiel		onbewerkt
	7700 320-006	Idem		RAL 9010 wit
	7700 320-901	Idem		RAL 9001 crème
	7700 320-755	Idem (*=structuurlak)		RAL 7016 antraciet*
		7500 419-000	Alu muurprofiel	4,11
7500 421-000		Idem	5,11	onbewerkt
7500 423-000		Idem	6,11	onbewerkt
7500 425-000		Idem	7,11	onbewerkt
7500 419-006		Alu muurprofiel	4,11	RAL 9010 wit
7500 421-006		Idem	5,11	RAL 9010 wit
7500 423-006		Idem	6,11	RAL 9010 wit
7500 425-006		Idem	7,11	RAL 9010 wit
7500 419-901		Alu muurprofiel	4,11	RAL 9001 crème
7500 421-901		Idem	5,11	RAL 9001 crème
7500 423-901		Idem	6,11	RAL 9001 crème
7500 425-901		Idem	7,11	RAL 9001 crème
	7500 419-755	Alu muurprofiel (*=structuurlak)	4,11	RAL 7016 antraciet*
	7500 421-755	Idem	5,11	RAL 7016 antraciet*
	7500 423-755	Idem	6,11	RAL 7016 antraciet*
	7500 425-755	Idem	7,11	RAL 7016 antraciet*
	7500 450-000	Afdekprofiel klik	6,0	onbewerkt
	7500 450-006	Idem	6,0	RAL 9010 wit
	7500 450-901	Idem	6,0	RAL 9001 crème
	7500 450-755	Idem (*=structuurlak)	6,0	RAL 7016 antraciet*

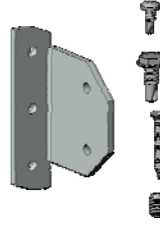
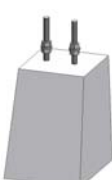









Piazza® Terrasoverkapping

	Artikelnr.	Omschrijving	Lengte in m ¹ / Verp.eenheid	Uitvoering
	7500 400-000	Ligger	6,0	onbewerkt
	7500 402-000	Idem	7,0	onbewerkt
	7500 400-006	Ligger	6,0	RAL 9010 wit
	7500 402-006	Idem	7,0	RAL 9010 wit
	7500 400-901	Ligger	6,0	RAL 9001 crème
	7500 402-901	Idem	7,0	RAL 9001 crème
	7500 400-755	Ligger (*=structuurlak)	6,0	RAL 7016 antraciet*
	7500 402-755	Idem	7,0	RAL 7016 antraciet*
	7500 480-000	Kunststof dakplaatdrager	3,7	wit
	7500 470-000	Dakplaat afsluitprofiel	6,2	onbewerkt
	7500 472-000	Idem	7,2	onbewerkt
	7500 470-006	Dakplaat afsluitprofiel	6,2	RAL 9010 wit
	7500 472-006	Idem	7,2	RAL 9010 wit
	7500 470-901	Dakplaat afsluitprofiel	6,2	RAL 9001 crème
	7500 472-901	Idem	7,2	RAL 9001 crème
	7500 470-755	Dakplaat afsluitprofiel (*=structuurlak)	6,2	RAL 7016 antraciet*
	7500 472-755	Idem	7,2	RAL 7016 antraciet*
	7500 460-000	Zijsluitprofiel	7,2	onbewerkt
	7500 460-006	Idem	7,2	RAL 9010 wit
	7500 460-901	Idem	7,2	RAL 9001 crème
	7500 460-755	Idem (*=structuurlak)	7,2	RAL 7016 antraciet*
	7700 100-000	Rubber voor kunststof dakplaatdrager en dakplaat afsluitprofiel	300	zwart
	7700 102-000	Afdichtingsrubber	60	zwart
	7700 104-000	Rubber voor dakplaat afsluitprofiel t.b.v. gelaagd glas 4.4.2	100	zwart
	7700 300-090	Afdekhoeck ligger	1	onbewerkt
	7700 300-006	Idem	1	RAL 9010 wit
	7700 300-901	Idem	1	RAL 9001 crème
	7700 300-755	Idem (*=structuurlak)	1	RAL 7016 antraciet*
	7500 430-000	Staander	5,0	onbewerkt
	7500 432-000	Idem	7,0	onbewerkt
	7500 430-006	Staander	5,0	RAL 9010 wit
	7500 432-006	Idem	7,0	RAL 9010 wit
	7500 430-901	Staander	5,0	RAL 9001 crème
	7500 432-901	Idem	7,0	RAL 9001 crème
	7500 430-755	Staander (*=structuurlak)	5,0	RAL 7016 antraciet*
	7500 432-755	Idem	7,0	RAL 7016 antraciet*

Piazza® Terrasoverkapping

	Artikelnr.	Omschrijving	Lengte in m ¹ / Verp.eenheid	Uitvoering
	7500 440-000	Afwerkprofiel staander	5,0	onbewerkt
	7500 442-000	Idem	7,0	onbewerkt
	7500 440-006	Afwerkprofiel staander	5,0	RAL 9010 wit
	7500 442-006	Idem	7,0	RAL 9010 wit
	7500 440-901	Afwerkprofiel staander	5,0	RAL 9001 crème
	7500 442-901	Idem	7,0	RAL 9001 crème
	7500 440-755	Afwerkprofiel staander (*=structuurlak)	5,0	RAL 7016 antraciet*
	7500 442-755	Idem	7,0	RAL 7016 antraciet*
	7700 327-068	Bevestigingsset	5m	
	7700 328-068	Bevestigingsset	7m	
		Bestaat uit:		
		Bevestigingsplaat liggers	12x 16x	
		Verzonken Plaatschroef RVS 4,2x32	40x 40x	
	Boorsch. CK/KK 4,2x13	80x 90x		
	Boorsch. 6-kant 6,3x19	15x 15x		
	7700 317-068	Betonpoer 20x17,5x25cm		grijs
	7700 319-000	Stelvoet		verzinkt
	7705 564-000	Polycarbonaat 980mm x 16 mm	3	opaal
	7705 554-000	Idem	3	helder
	7705 510-000	Idem	3,5	opaal
	7705 559-000	Idem	3,5	helder
		Bovenstaande platen zijn reeds voorzien van dichte tape aan muurzijde en open tape aan gootzijde.		
	7701 075-000	Afdichtingstape gesloten 38mm	133	grijs
	7701 075-080	Idem	10	grijs
	7701 076-000	Afdichtingstape open 38mm	100	grijs
	7701 076-080	Idem	10	grijs
	7500 280-000	Randafwerkprofiel 16mm voor bovenstaande platen	5,5	onbewerkt
	7500 280-006	Idem	5,5	RAL 9010 wit
	7500 280-901	Idem	5,5	RAL 9001 crème
	7500 280-755	Idem (*=structuurlak)	5,5	RAL 7016 antraciet*
	7700 386-000	Houder t.b.v. gatenzaag		

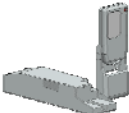
Piazza® Terrasoverkapping

Artikelnr.	Omschrijving	Lengte in m ¹ / Verp.eenheid	Uitvoering
	7700 388-000 Gatenzaag Ø83mm t.b.v. montage PVC bladvanger (7700348-068)		
	7700 390-000 Getrapte boor 8-34 mm t.b.v. inbouw verlichtingsset (7700110-000)		
	7700 340-000 PVC buis 80mm	5,55	grijs
	7700 344-000 PVC bocht 80mm mof/spie 45°		grijs
	7700 342-000 PVC bocht 80mm mof/verjongd spie-eind 45°		grijs
	7700 348-068 PVC bladvanger		grijs
	7700 110-000 Verlichtingsset Bestaat uit: -3x halogeen spot 20W -trafo -kabel 4 meter per spot -verdeelblok		RVS
	7700 114-000 Halogeenspot (20W)		
	7700 112-000 Dimmer (230W) met afstandbediening		
	4000 858-000 Dimmer Somfy		
	4001 316-000 Handzender Telis 1 Somfy		

Piazza® Terrasoverkapping

Artikelnr.	Omschrijving	Lengte in m ¹ / Verp.eenheid	Uitvoering
------------	--------------	--------------------------------------------	------------

LET OP: Onderstaande artikelen zijn op bestelling leverbaar en bv. te gebruiken voor afdichting van de zijkant van de Piazza® met Polycarbonaatplaten. Hiervoor dienen de rubbers uit de profielen verwijderd te worden.

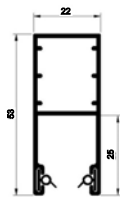

7500 530-000	Zijgeleider HTF 53 x 22 mm	6,0	onbewerkt
7500 530-006	Idem	6,0	RAL 9010 wit
7500 530-901	Idem	6,0	RAL 9001 crème
7500 530-755	Idem (*=structuurlak)	6,0	RAL 7016 antraciet*

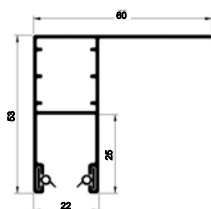

7500 532-000	Zijgeleider LHTF 53 x 22 mm	6,0	onbewerkt
7500 532-006	Idem	6,0	RAL 9010 wit
7500 532-901	Idem	6,0	RAL 9001 crème
7500 532-755	Idem (*=structuurlak)	6,0	RAL 7016 antraciet*

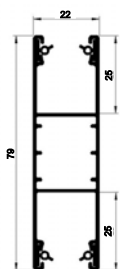

7500 534-000	Zijgeleider M-HTF / HU 25 - 79 x 22 mm	6,0	onbewerkt
7500 534-006	Idem	6,0	RAL 9010 wit
7500 534-901	Idem	6,0	RAL 9001 crème
7500 534-755	Idem (*=structuurlak)	6,0	RAL 7016 antraciet*

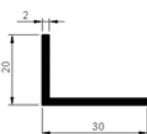

1203 270-000	Hoek 30 x 20 x 2 mm	6,0	onbewerkt
1203 270-006	Idem	6,0	RAL 9010 wit
1203 270-901	Idem	6,0	RAL 9001 crème
1203 270-755	Idem (*=structuurlak)	6,0	RAL 7016 antraciet*

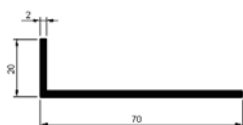

1203 863-000	Hoek 70 x 20 x 2 mm	6,0	onbewerkt
1203 863-006	Idem	6,0	RAL 9010 wit
1203 863-901	Idem	6,0	RAL 9001 crème
1203 863-755	Idem (*=structuurlak)	6,0	RAL 7016 antraciet*